

**HITACHI SOLID STATE
STEREOPHONIC RADIO PHONOGRAPH**

**MODEL DPK-321(U)
SUPPLEMENT
SERVICE MANUAL**

NO. 19-1 1971



Model DPK-321(U) is improved by modifying part of the circuit and replacing a few parts as follows;

- 1) The old model picked up short wave signals sometimes during AM broadcast reception.
To avoid this trouble, in sets from Serial No.35201501 part of RFPCB and the ferrite antenna are modified.
- 2) Varister HV-26 and power transistor 2SC830 are replaced with diode VO-6C and power transistor 2SC1060 respectively (Both interchangeable).

I. SPECIFICATIONS

BEFORE ALTERATION	AFTER ALTERATION
Amplifier Diodes.....25	Diodes.....24
AM tuner Sensitivity.....170 μ V/m(IHF S/N20dB)	Sensitivity300 μ V/m(IHF S/N20dB)

2. DIAL CORD SETTING

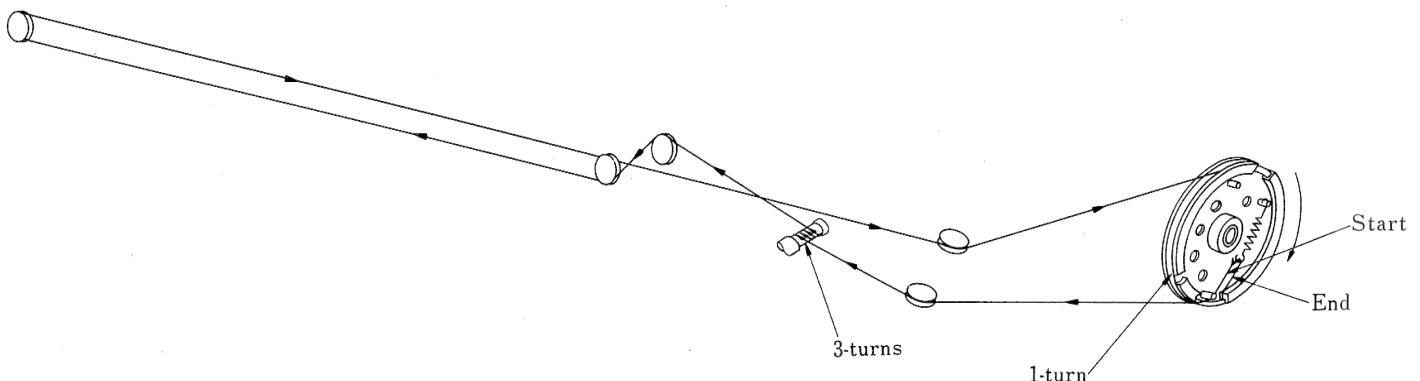

3. CIRCUIT BOARD

IF · MPX CIRCUIT BOARD

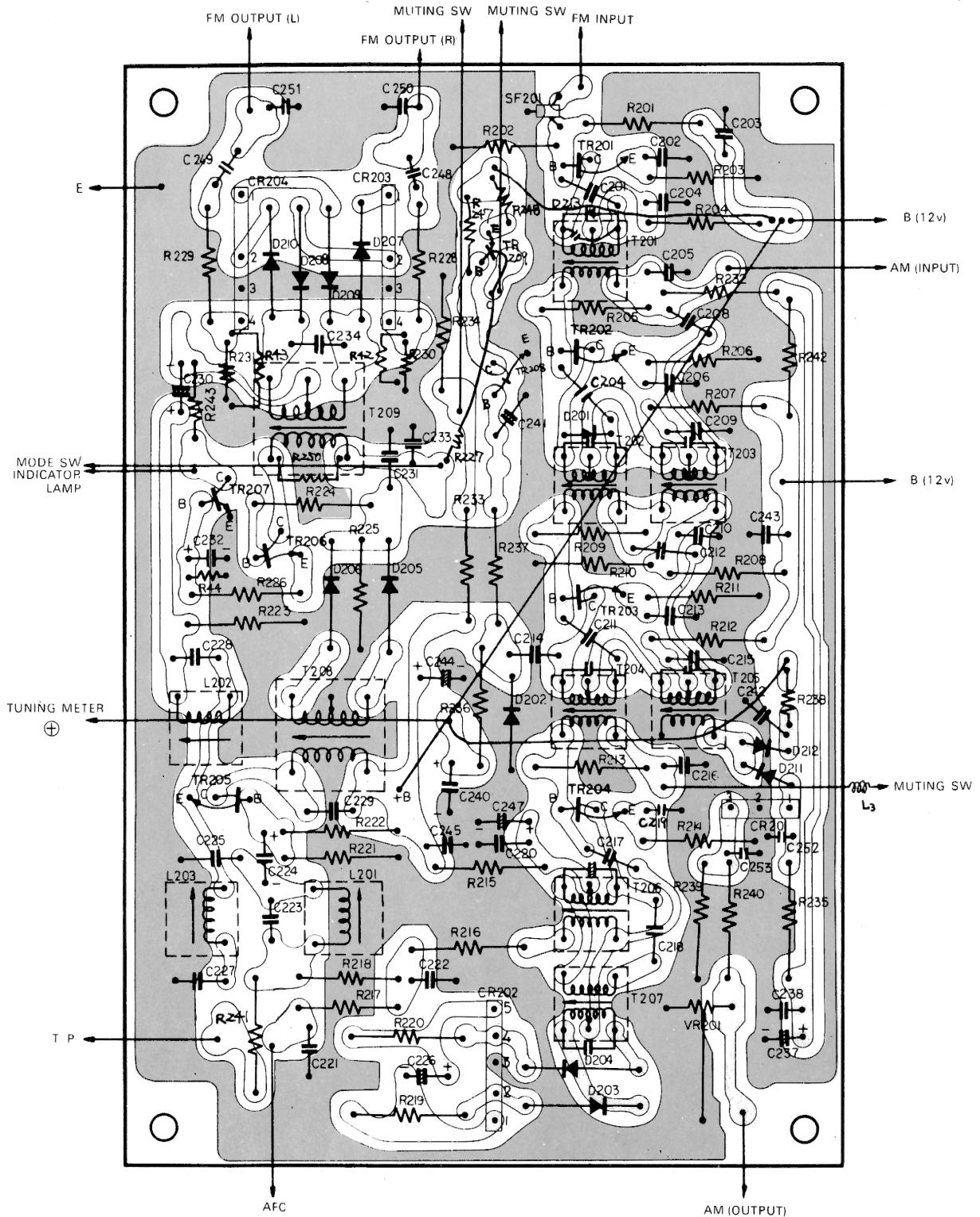

RF CIRCUIT BOARD

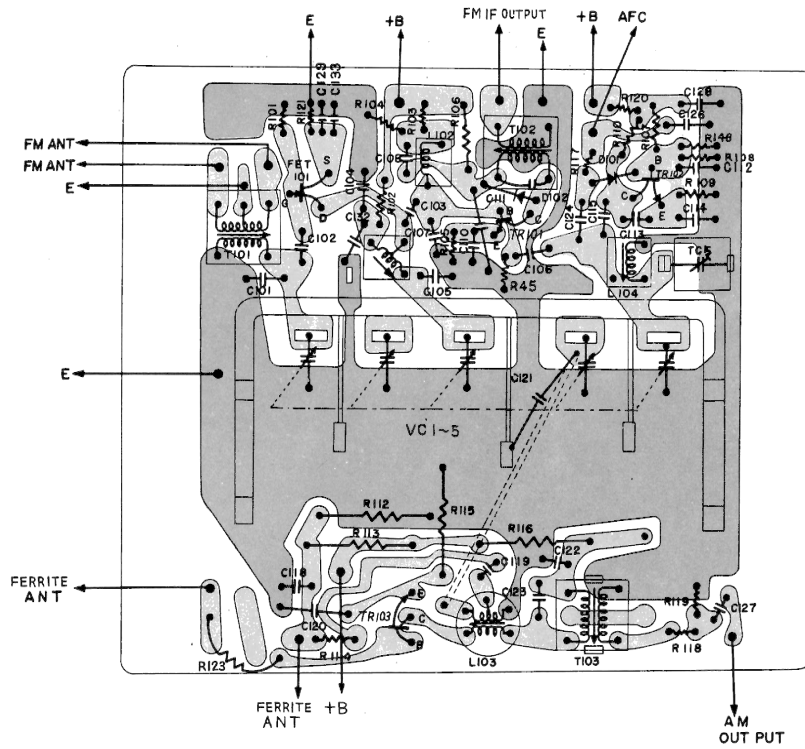

EQUALIZER CIRCUIT BOARD

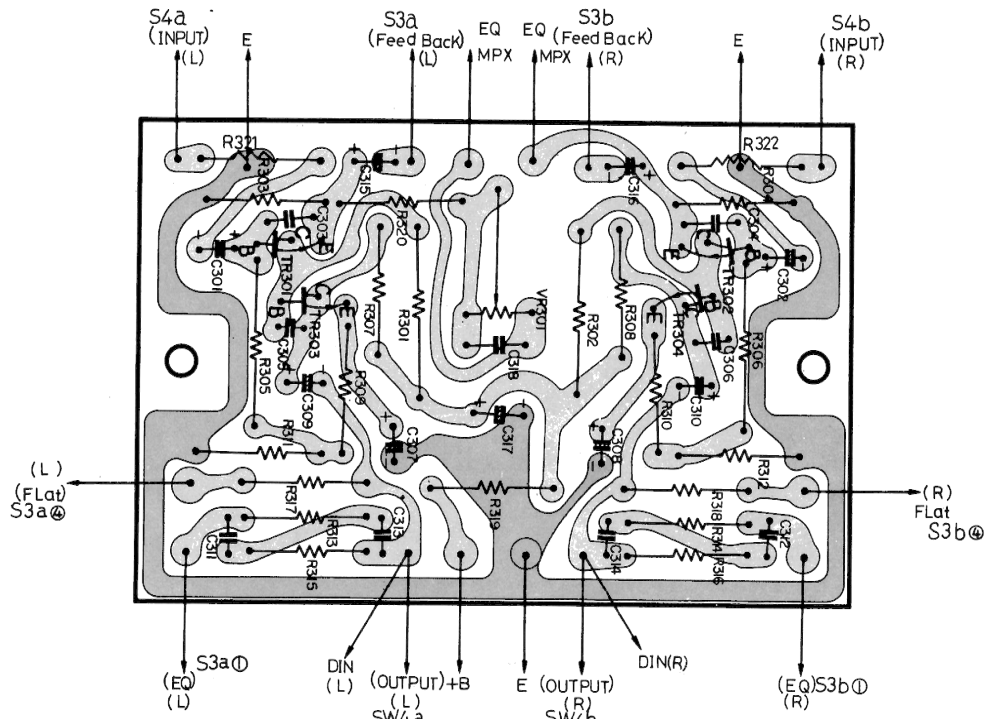

MODEL DPK-321 SERVICE MANUAL

MAIN AMP CIRCUIT BOARD

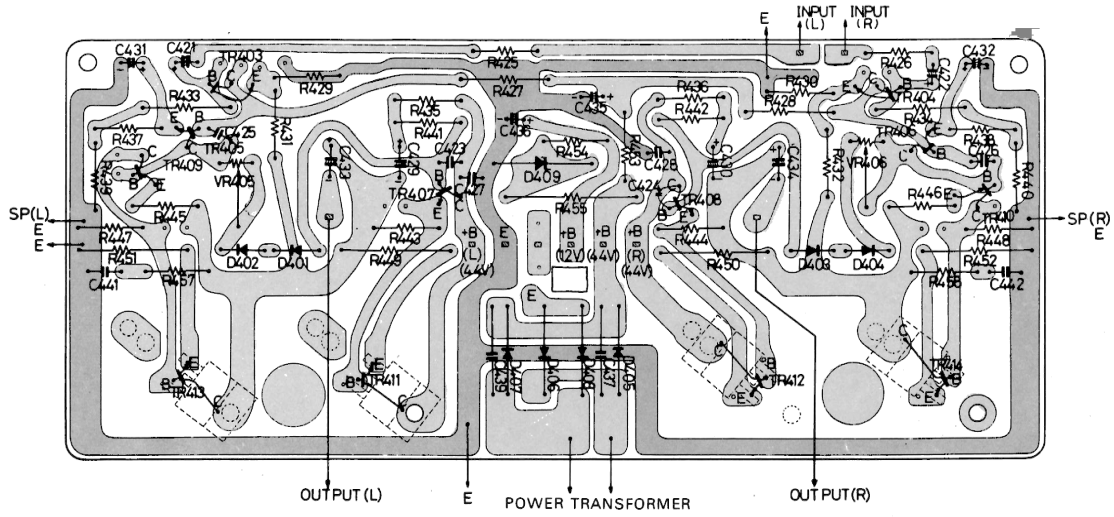

PRE-AMP CIRCUIT BOARD

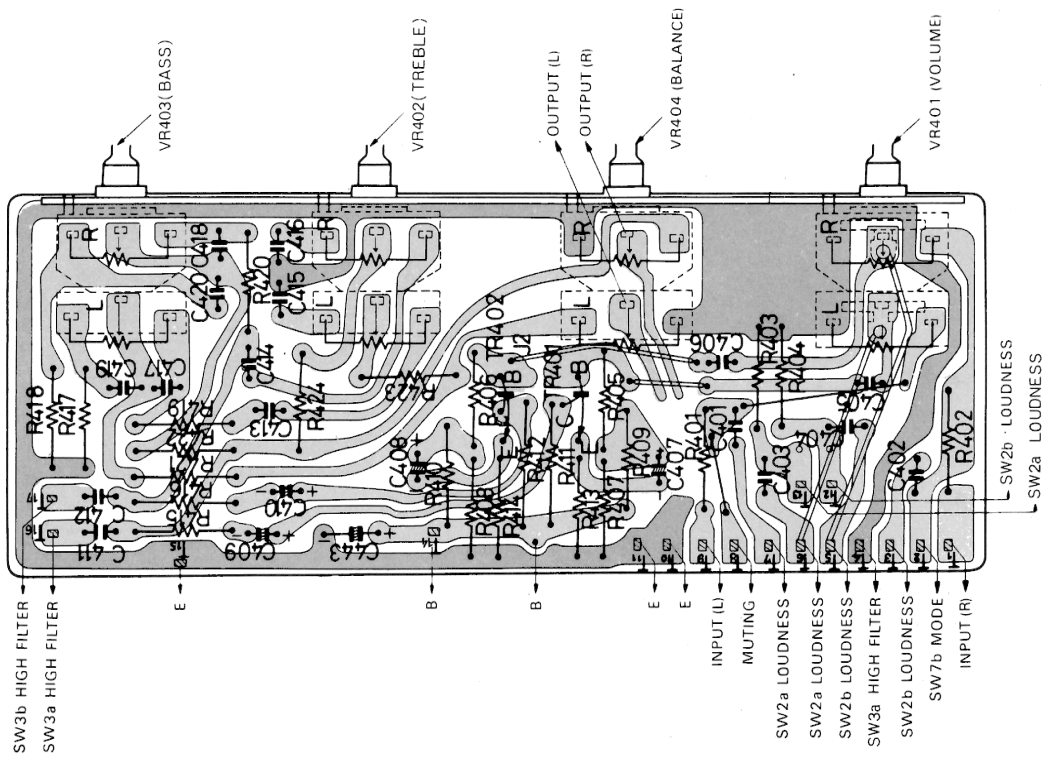

4. STANDARD CIRCUIT DIAGRAM

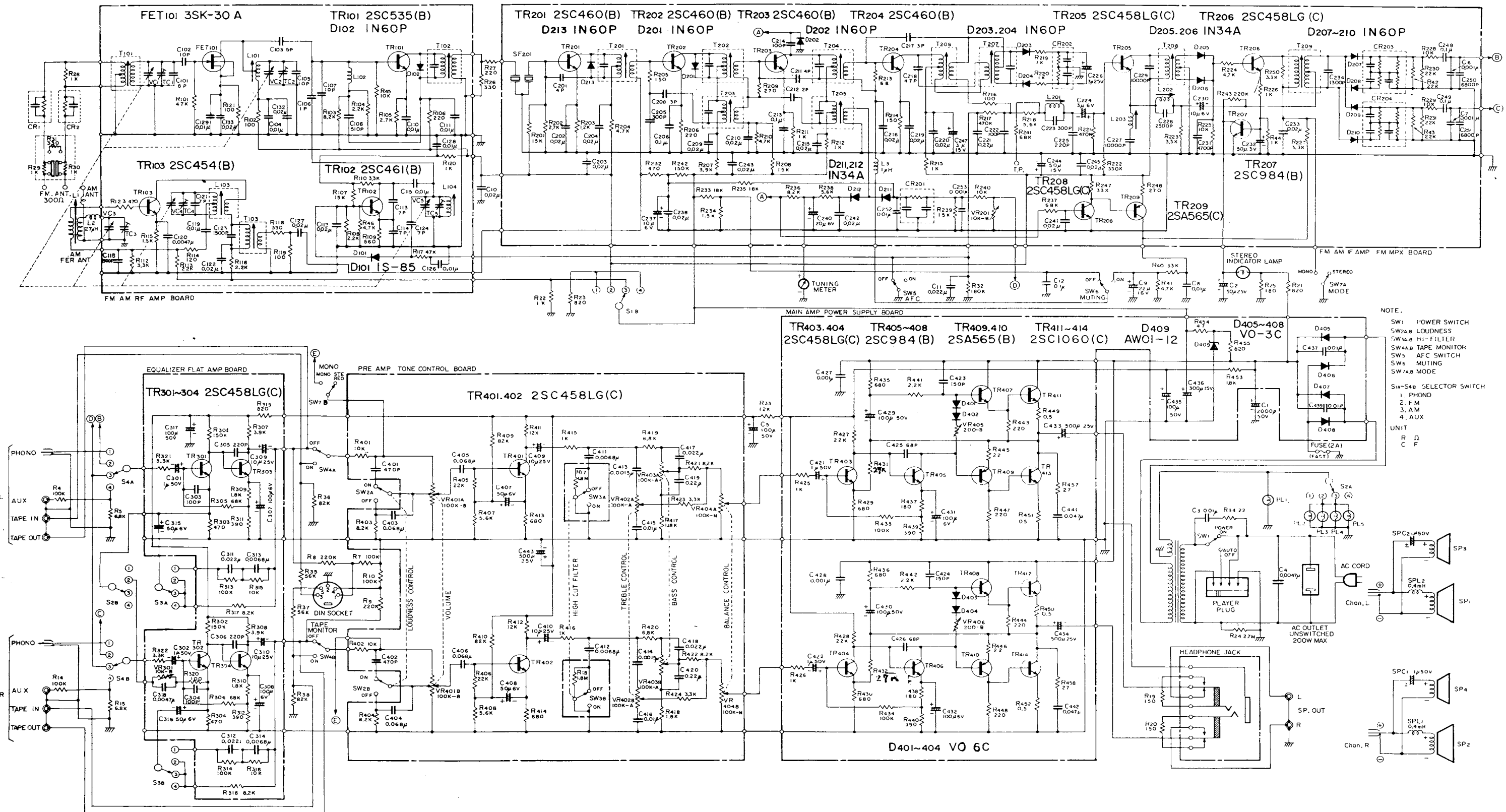

5. REPLACEMENT PARTS LIST

Note: * changed parts
O newly added parts
□ removed parts

Table with columns: SYMBOL NO., STOCK NO., DESCRIPTION. Sections include RF CIRCUIT BOARD, CAPACITORS, RESISTORS, TRANSISTORS, DIODES, COILS & TRANSFORMERS, OTHERS, IF-MPX CIRCUIT BOARD, and RESISTORS.

Table with columns: SYMBOL NO., STOCK NO., DESCRIPTION. Sections include TRANSISTORS, DIODES, COILS & TRANSFORMERS, OTHERS, EQUALIZER CIRCUIT BOARD, CAPACITORS, RESISTORS, and OTHERS.

MODEL DPK-321 SERVICE MANUAL

SYMBOL NO.	STOCK NO.	DESCRIPTION	SYMBOL NO.	STOCK NO.	DESCRIPTION
R422	0114472	Carbon film	*TR412	2327203	Transistor
R423	0114467	Carbon film	*TR413	2327203	Transistor
R424	0114467	Carbon film	*TR414	2327203	Transistor
VR401	0153686	Variable	DIODES		
VR402	0153685	Variable	*D401	2327041	Diode
VR403	0153685	Variable	*D402	2327041	Diode
VR404	0153687	Variable	*D403	2327041	Diode
TRANSISTORS			*D404	2327041	Diode
TR401	2320073	2SC458LG Ⓞ	D405	2327031	Diode
TR402	2320073	2SC458LG Ⓞ	D406	2327031	Diode
OTHERS			D407	2327031	Diode
	2517441	PRE-AMP circuit board assembly	D408	2327031	Diode
MAIN-AMP CIRCUIT BOARD			D409	2327071	Zener diode
CAPACITORS			OTHERS		
C421	0252811	Electrolytic	4354401		Radiator (A)
C422	0252811	Electrolytic	4354521		Radiator (B)
C423	0248728	Ceramic, discal	2517451		MAIN-AMP circuit board assembly
C424	0248728	Ceramic, discal	FOR CHASSIS ASSEMBLY		
C425	0248720	Ceramic, discal	CAPACITORS		
C426	0248720	Ceramic, discal	C 1	0259757	Electrolytic
C427	0274011	Polyester, film	C 2	0252825	Electrolytic
C428	0274011	Polyester, film	C 3	0214469	Oil
C429	0252831	Electrolytic	C 4	0243873	Ceramic, discal
C430	0252831	Electrolytic	C 5	0253408	Electrolytic
C431	0252231	Electrolytic	C 6	0274111	Polyester film
C432	0252231	Electrolytic	C 7	0274111	Polyester film
C433	0252635	Electrolytic	C 8	0245017	Ceramic, discal
C434	0252635	Electrolytic	C 9	0253381	Electrolytic
C435	0252831	Electrolytic	C 10	0245018	Ceramic, discal
C436	0252533	Electrolytic	C 11	0275113	Polyester film
C437	0245408	Ceramic, discal	○ C 12	0246007	Ceramic, discal
C439	0245408	Ceramic, discal	RESISTORS		
C441	0275015	Polyester, film	R 4	0112533	Carbon film
C442	0275015	Polyester, film	R 5	0112384	Carbon film
RESISTORS			R 7	0112533	Carbon film
R425	0114461	Carbon film	R 8	0134401	Composition
R426	0114461	Carbon film	R 9	0134401	Composition
R427	0112467	Carbon film	R 10	0112533	Carbon film
R428	0112467	Carbon film	R 14	0112533	Carbon film
R429	0114451	Carbon film	R 15	0112384	Carbon film
R430	0114451	Carbon film	R 17	0134412	Composition
*R431	0114526	Carbon film	R 18	0134412	Composition
*R432	0114526	Carbon film	R 19	0134363	Composition
R433	0112533	Carbon film	R 20	0134363	Composition
R434	0112533	Carbon film	R 21	0111417	Metal oxide
R435	0114451	Carbon film	R 22	0134373	Composition
R436	0114451	Carbon film	R 23	0134372	Composition
R437	0114444	Carbon film	R 24	0134414	Composition
R438	0114444	Carbon film	R 25	0134364	Composition
R439	0114448	Carbon film	R 26	0114447	Carbon film
R440	0114448	Carbon film	R 27	0114445	Carbon film
R441	0114465	Carbon film	R 28	0114461	Carbon film
R442	0114465	Carbon film	R 29	0114461	Carbon film
R443	0114445	Carbon film	R 30	0114461	Carbon film
R444	0114445	Carbon film	R 31	0114447	Carbon film
R445	0114375	Carbon film	R 32	0114549	Carbon film
R446	0114375	Carbon film	R 33	0134370	Composition
R447	0114445	Carbon film	R 34	0134293	Composition
R448	0114445	Carbon film	R 35	0114219	Carbon film
R449	0149105	Wire wounded	R 36	0114526	Carbon film
R450	0149105	Wire wounded	R 37	0114219	Carbon film
R451	0149105	Wire wounded	R 38	0114526	Carbon film
R452	0149105	Wire wounded	R 40	0114527	Carbon film
R453	0114464	Carbon film	R 41	0114469	Carbon film
R454	0114379	Carbon film	R 42	0114525	Carbon film
R455	0111417	Metal oxide	R 43	0114525	Carbon film
R457	0134294	Composition	R 44	0114461	Carbon film
R458	0134294	Composition	R 45	0114521	Carbon film
VR405	0151223	Variable	R 46	0114469	Carbon film
VR406	0151223	Variable	OTHERS		
TRANSISTORS			CR 1	4560353	Shaft—Tuning shaft assembly
TR403	2320073	Transistor	CR 2	0599675	CR couplate
TR404	2320073	Transistor		0599675	CR couplate
TR405	2327022	Transistor		3910251	Arm—Antenna arm assembly
TR406	2327022	Transistor		4116332	Nut—8 mm ϕ nut
TR407	2327022	Transistor		4513311	Screw—Earth screw
TR408	2327022	Transistor	*SW 1	2637034	Switch—Lever switch
*TR409	2320161	Transistor	SW 2~7	2610071	Switch—Lever switch
*TR410	2320161	Transistor		2617081	Switch—Rotary switch
*TR411	2327203	Transistor		2627011	Switch—Slide switch
				2577081	Meter—Tuning meter

MODEL DPK-321 SERVICE MANUAL

SYMBOL NO.	STOCK NO.	DESCRIPTION	SYMBOL NO.	STOCK NO.	DESCRIPTION
PL1 PL2-5	2760051 2760061 2767081 2720021 2650132 2740241 3715182 2650141 2727062 2720031 0541358 2670061 2681351	Lamp—Pilot lamp (fuse type 6.3V 0.15A) Lamp—Pilot lamp (6.3V 0.15A) Lamp—Pilot lamp (5.5V 22mA) Socket—Pilot lamp socket (fuse type) Socket—Pilot lamp socket Cord—AC cord Bushing Socket—AC socket Holder—Fuse holder Fuse—Fuse (2A) fast Socket—5P socket (rec & p.b.) Pin jack—2P US pin jack Terminal board—Antenna terminal board (3P bolt terminal)			
* L 1 L 2 L 3	2677062 2667015 2780641 2757071 2227035 2227041 2217131 0544404 2687062 0544404 4720512 0544384 2687072	Jack—Headphone jack Socket—Amp rock Crip—Cord crip Ferrite antenna Choke coil (27 μ H) Choke coil (1 μ H) Power transformer Terminal board—2P terminal board Terminal board—2P terminal board Terminal board—6P terminal board Clamp Terminal board—4P terminal board Terminal board—4P terminal board			
* O O					
			SP1, 2 SP3, 4 SPC1.2	3197791 3910173 4680281 3386121 0662084 0666704 3712283 3240275 3280302 3280371 4511353 0040045 3710471 3911243 4920991 4922291 4770254 4921021 0044227 4720971 2410151 2410041 0257051 2687081 0544402 2270051 3711861	MISCELLANEOUS for Dial mechanism assembly Dial scale Indicator—Dial indicator Cover—Indicator cover Dial pointer assembly Spring Cord—Dial cord holding fixture Pulley—Dial pulley for Final assembly Escutcheons assembly Knob—Knob for Knob—Knob for Bolt—4 mm ϕ \times 25 mm bolt Washer—F10 washer Cap—Headphone cap Cover—Dust cover assembly for Cabinet assembly Cabinet—Speaker cabinet assembly Cabinet—Center cabinet assembly Nut—Nut with 3 ϕ washer { for speaker { for network coil Cover—M321 back-cover for speaker cabinet Screw—3.1mm ϕ \times 20 mm screw Cover—Choke cover Speaker—20 cm speaker Speaker—Phone tweeter Electrolytic capacitor (1 μ F 50V) Terminal board—2P terminal board (for speaker terminal) Terminal board—2P terminal board Coil—Network coil (0.4mH) Leg—S45 leg
					ACCESSORIES
				0043491 4355124 2747171	FM antenna assembly Player driver Cord—Speaker junction cord

HITACHI SALES CORPORATION OF AMERICA

New York 48-50, 34th Street, Long Island City, N.Y. 11101
Tel. (212) 361-3090

Chicago 1400 Morse Ave., Elk Grove Village, Chicago,
Illinois 60007 Tel.(312)593-7500

Los Angeles 2550 Santa Fe Ave. Redondo Beach Calif. 90278
Tel. (213) 644-3655 (213) 772-6571

Dallas 1121 Round Table Drive, Dallas, Texas 75247
Tel. (214) 638-5820

HITACHI SALES CORPORATION OF HAWAII, INC.

743-G Waiakamilo Road, Honolulu, Hawaii 96817
Tel. 841-431

HITACHI SALES CORPORATION OF CANADA LTD.

9601 Cote De Liesse Rd. Dorval 760, P.Q.



Head Office : 5-1, 1-chome, Marunouchi, Chiyoda-ku, Tokyo
Tel. Tokyo (212) 1111 (80 lines)

Cable Address : "HITACHY" TOKYO

Codes : All Codes Used